

IB45CS

Built-in Steam Combi Oven



INSTRUCTION MANUAL

PLEASE READ THE INSTRUCTION MANUAL CAREFULLY BEFORE USING THE UNIT.

WARNINGS AND PRECAUTIONS	1
PARTS AND ACCESSORIES	3
INSTALLATION	4
OPERATION	6
Before First Use	6
Controls	7
Utensils and Materials	16
Automatic Program Index	17
CLEANING AND MAINTENANCE	20
Cleaning	20
Maintenance	20
Disposal	21
TECHNICAL & REFERENCE DATA	22
Model Specifications	22
Warranty	22

IMPORTANT INFORMATION

To reduce the risk of injury to users, fire, electric shock or exposure to excessive microwave oven energy when using your appliance, follow the caution warnings listed below. Please retain this manual for product warranty and for future reference.

CAUTION

- Install or locate this oven only in accordance with the installation instructions provided.
- Do not store or use this appliance outdoors.
- Do not use this oven near water, in a wet basement or near a swimming pool.
- Accessible parts may become hot during use. Keep cord away from heated surfaces, and do not cover any vents on the oven. Do not let cord hang over edge of table or counter. Keep the appliance and its cord out of the reach of children.
- Do not attempt to operate this oven with the door open since this can result in harmful exposure to microwave energy.
- Do not tamper with the safety interlocks as this can lead to damage.
- Do not place any object between the oven front face and the door or allow soil or cleaner residue to accumulate on sealing surfaces.
- If the door or door seals are damaged, the oven must not be operated until it has been repaired by a service agent.
- If the power cord is damaged, it must be replaced by an authorised service agent in order to avoid a hazard.
- It is hazardous for anyone other than an qualified service agent to carry out any service or repair operation that involves the removal of a cover which gives protection against exposure to microwave energy.
- Liquids and other foods must not be heated in sealed containers since they are liable to explode.
- This appliance is not intended for use by persons (including children) with reduced physical, sensory or mental capabilities, or lack of experience and knowledge, unless they have been given supervision or instruction concerning use of the appliance by a person responsible for their safety.

- Children should be supervised to ensure that they do not play with the appliance.
- The appliance is not intended to be operated by means of an external timer or separate remote-control system.
- Only use utensils suitable for use in microwave ovens when using the microwave function (see page 16).
- The oven should be cleaned regularly and any food deposits should be removed.
- When heating food in plastic or paper containers, monitor with caution due to the possibility of ignition.
- If smoke is emitted, switch off or unplug the appliance and keep the door closed.
- Do not overcook food.
- Do not run the appliance without any food inside.
- Do not use the oven cavity for storage purposes.
- The microwave oven function is intended for heating food and beverages. Drying of food or clothing and heating of warming pads, slippers, sponges and similar may lead to risk of injury or fire.
- Remove wire twist-ties and metal handles from paper or plastic containers/bags before placing them in the appliance.
- Failure to maintain the oven in a clean condition could lead to deterioration of the surface that could adversely affect the life of the appliance and possibly result in a hazardous situation.
- Microwave heating of beverages can result in delayed eruptive boiling, therefore care must be taken when handling the container.

IMPORTANT

Do not disassemble this appliance. Touching of the internal components by an unqualified person is dangerous and could cause serious injury.

The accessible surface may be hot during operation.



- 1. Control panel
- 2. Grill element
- 3. Light
- 4. Level
- 5. Door glass
- 6. Hinge
- 7. Grill rack
- 8. Glass pan
- 9. Water tank for the steam function

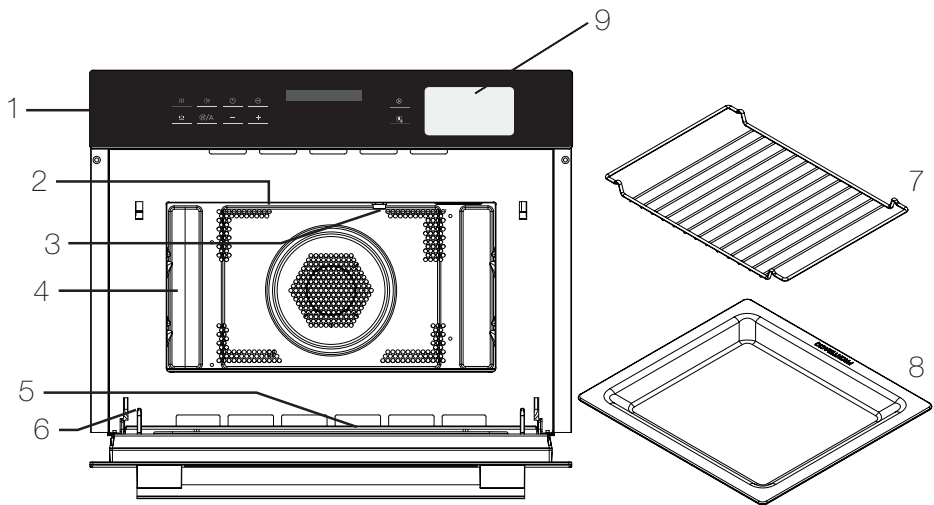

- This appliance is NOT intended for use in commercial environments.
- Please observe the installation instructions provided and note that this appliance should only be installed by a qualified technician. Incomplete or improper installation could lead to safety issues and make your warranty void.
- The fitter is liable for any damage resulting from incorrect installation.
- This appliance is only intended to be fully fitted in a kitchen.
- This appliance is not designed to be used as a tabletop appliance or inside a cupboard.
- The fitted cabinet must not have a back wall behind the appliance. A gap of at least 45mm must be maintained between the wall and the base/back panel of the unit. There must also be a ventilation opening of 25cm² on the front of the fitted cabinet - to achieve this, cut back the base panel or fit a ventilation grille.
- Ventilation slots and intakes must not be covered.
- The unit into which the appliance is fitted must be heat-resistant up to 90°C.
- Do not hold or carry the appliance by the door handle. The door handle cannot hold the weight of the appliance and may break off.

Ventilation openings

behind, min. 25cm²

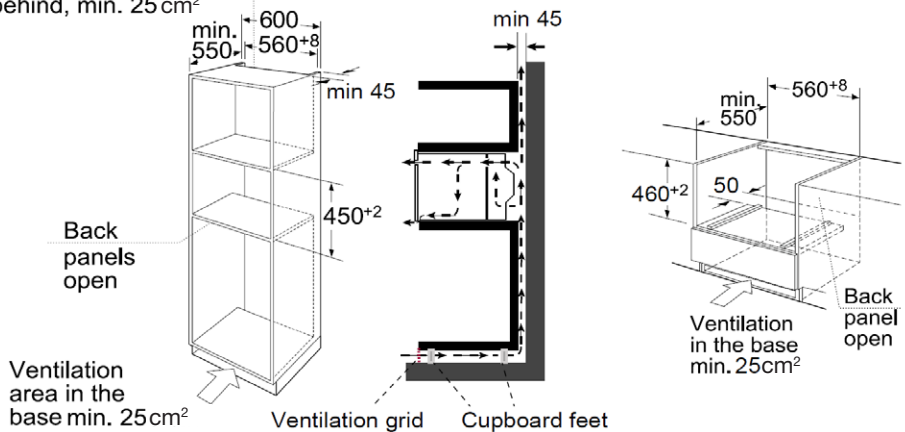

Note: There should be gap above the oven.

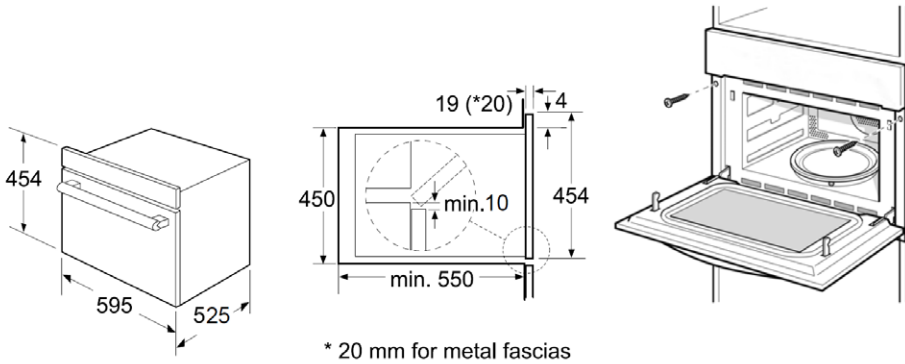

1. Fully insert the appliance and centre it. Do not kink the connecting cable.
2. Open the door and fasten the oven with supplied screws.
3. The gap between the worktop and the appliance must not be closed by additional battens.

IMPORTANT

In case a new socket is needed, installation and cable connection must only be done by a qualified electrician. Adapters, multi-way strips and extensions cords must not be used. Overloading can result in fire.





Connect the wires of the mains power cord in accordance with the following colour coding:

Green and yellow	Earth wire (E)	
Blue	Neutral wire (N)	
Brown	Live (L)	

Do not connect the appliance using a 13 A plug or protect it with a 13 A fuse. Only use a fuse that is rated 16 A or higher. The appliance must be disconnected from the power supply during all installation work. When the appliance is installed, protection must be provided against accidental contact in the future.

This appliance must be grounded. Improper use of grounding can result in electric shock. Consult a qualified professional if doubt exists as to whether the appliance is properly grounded.

BEFORE FIRST USE

- Please read these instructions carefully before use and keep them for future reference.
 - Check your local main voltage whether it is the same as stated on the appliance.
 - Remove any protective films from the appliance surfaces and all materials from the carton and oven cavity.
1. Remove all accessories and wash out the cavity.
 2. New appliances typically smell when first used. 'Burn' the appliance off by touching  to turn the appliance on. The main menu will appear in the display.
 3. Touch  to choose the convection function.
 4. Recommended temperature will be highlighted. Raise the temperature to the maximum by touching  and then touch the .
 5. Touch  to start the oven, heat the empty oven for at least an hour. Make sure that the room is well ventilated, close the doors to the other rooms to avoid odours pervading the house.
 6. Let the appliance cool down to room temperature. Make a solution of detergent mixed with hot water to clean inside the microwave oven, then wipe dry with a clean soft cloth. Keep the door open until the oven cavity is completely dry.

CONTROLS

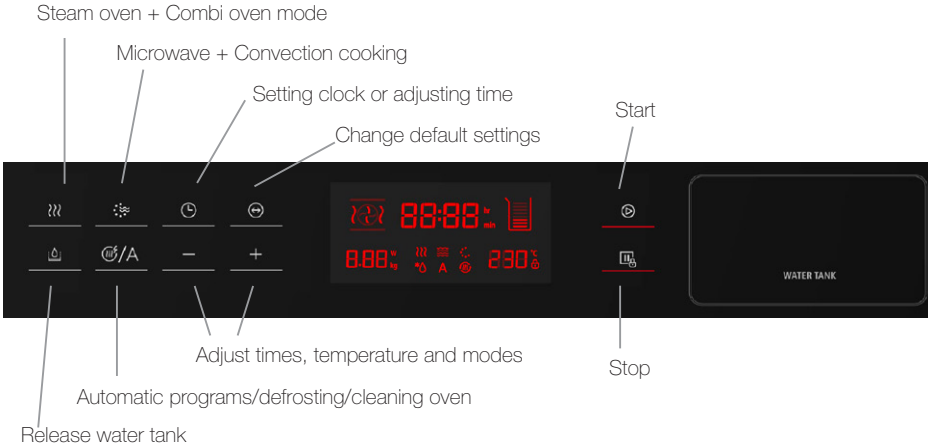

The button goes through multiple functions in the following order:

- Microwave
- Convection/Fanned oven
- Fanned Grill
- Grill
- Microwave + Convection/Fanned oven
- Microwave + Fanned Grill

You can find a step to step guide for using each of these functions on page 8 - 11

The button goes through steam and steam combination functions in the following order:

- Steam
- Steam + Microwave
- Steam + Convection/Fanned oven

You can find a step to step guide for using each of these functions on page 12 - 13

The button goes through other functions in the following order:

- Defrost
- Automatic Programs (Steam and non-steam)
- Clean

You can find a step to step guide for using each of these functions on page 14 - 15

The display will change symbols to show which function is selected.

1. Clock Setting



When the oven is initially connected, "00:00" will blink and the buzzer will ring once. To set the time press **-** or **+** to adjust the blinking numbers. When adjusting the minutes you can short press the **-** or **+** to adjust in 1 min increments, or press and hold the buttons to adjust in 10 min increments. After you have reached the correct time, press  to set.

Note: To change the set time, you have to press and hold the  button for 3 seconds. The actual time disappears and then the time will blink in the display. Repeat the previous instruction to set the time.

2. Microwave Cooking

Touch the  once, the appliance will enter the microwave mode. You will notice the screen showing the default power 900W and default time of 10:00 minutes.

To change the wattage, touch the  and when the 900 is flashing touch the **-** to lower the wattage. (Minimum of 100 watts)

To change the time, touch the  and when the 10:00 minutes is flashing, touch **+** or **-** to give desired time. Touch the  to start.



If at any time an error has been made, simply touch the  (stop) and start again.





Microwave Power	100%	80%	50%	30%	20%
Display	900W	700W	450W	300W	100W

Power Level	Food
900W	Boiling water, reheating. Cooking chicken, fish, veggies.
700W	Reheating. Cooking mushrooms and shell fish. Cooking dishes containing eggs and cheese.
450W	Cooking rice, soup
300W	Defrosting. Melting chocolate and butter
100W	Defrosting sensitive/delicate foods. Defrosting irregularly-shaped foods. Softening ice cream. Allowing dough to rise.

3. Convection Oven Cooking



Touch the  twice to get into convection cooking mode, the screen will show the default oven temperature of 180°C and default time of 10:00 minutes.



To adjust the temperature, touch the  and when 180°C is flashing, use the  or  to increase or decrease the temperature. The default temperature is 180°C but the temperature can be set from 50 - 230°C.

To change the time, touch the  and when the 10:00 minutes is flashing, touch  or  to give desired time. Touch the  to start. The max time is 5 hours.

4. Fanned Grill

Touch the  three times to get into fanned grill mode, the screen will show the default temperature of 180°C and default time of 10:00 minutes.





To adjust the temperature, touch the  and when 180°C is flashing, use the  or  to increase or decrease the temperature. The default temperature is 180°C but the temperature can be set from 35 - 180°C.

To change the time, touch the  and when the 10:00 minutes is flashing, touch  or  to give desired time. Touch the  to start. The max time is 5 hours.

5. Grill

Touch the  four times to get into the grill function, the screen will show the default grilling level of 3 and default time of 10:00 minutes.

To adjust the level of grilling, touch the  and when the 3 is flashing, use the  to decrease the grilling level to either 1 or 2.

To change the time, touch the  and when the 10:00 minutes is flashing, touch  or  to give desired time. Touch the  to start. The max time is 90 mins.

6. Microwave + Convection/Fanned oven

Touch the  five times to get into microwave + convection combination mode, the screen will show the default oven temperature of 180°C, default power of 300W and default time of 10:00 minutes.

To adjust the temperature, touch the  and when 180°C is flashing, use the **+** or **-** to increase or decrease the temperature to 50 - 230°C.

To change the wattage, touch the  again and when the 300 is flashing touch **+** or **-** to increase or decrease the wattage to 100W - 700W.

To change the time, touch the  and when the 10:00 minutes is flashing, touch **+** or **-** to give desired time. Touch the  to start. The max time is 90 mins.

7. Microwave + Fanned Grill

Touch the  six times to get into microwave + fanned grill combination mode, the screen will show the default oven temperature of 180°C, default power of 300W and default time of 10:00 minutes.

To adjust the temperature, touch the  and when 180°C is flashing, use **-** to decrease the temperature to 100 - 180°C.

To change the wattage, touch the  again and when the 300 is flashing touch **+** or **-** to increase or decrease the wattage to 100W - 700W.

To change the time, touch the  and when the 10:00 minutes is flashing, touch **+** or **-** to give desired time. Touch the  to start. The max time is 90 mins.

8. Microwave + Grill

Touch the  seven times to get into the microwave + grill function, the screen will show the default grilling level of 3, default power of 300W and default time of 10:00 minutes.

To adjust the level of grilling, touch the  and when the 3 is flashing, use the  to decrease the grilling level to either 1 or 2.



To change the wattage, touch the  again and when the 300 is flashing touch  or  to increase or decrease the wattage to 100W - 700W.

To change the time, touch the  and when the 10:00 minutes is flashing, touch  or  to give desired time. Touch the  to start. The max time is 90 mins.

9. Preheating Function

The preheating function can be activated after you have set any of the following functions: Convection/Fanned oven, Fanned Grill, Microwave + Fanned Grill, Microwave + Convection/Fanned oven

Touch the /A and the preheat icon () will appear in the display. Ensure you have selected your desired temperature correctly.

Touch the  to start preheating. When the right temperature has been reached the buzzer will ring 3 times. You can stop the preheating by opening the oven door or touching the .

This function will only work if you have chosen one of the modes listed above.

During the preheating, the microwave function is switched off. During preheating, don't put the food in the oven. Only when the temperature is reached, can you put in the food to start cooking.

10. Steam Cooking Function





Before starting the steam cooking function, please clean the water tank.

During the steam cooking function, if the tank is short on water a buzzer will ring while the screen icon will show water status is low to remind you to add water. To add water touch the  to release the water tank. Fill the tank with water and place it back into the appliance and cooking will resume.

After the steam cooking function is finished, the water in the boiler will be withdrawn back to the water tank. This process can last for about 1 minute. During this process if the water tank is full, the buzzer will beep 10 times to remind you to empty the tank. After the water tank has been emptied the system will continue to withdraw water. After steam cooking, please remove the water from the water tank.

Touch the  once, the appliance will enter the steam mode. You will notice the screen showing the default steam level 100 (this is displayed as a temperature but it is a percentage) and default time of 10:00 minutes. The current water level will also be displayed.

To change the steam level, touch the  and when the 100° is flashing touch the  to decrease the steam level to anywhere between 50 - 100.



To change the time, touch the  and when the 10:00 minutes is flashing, touch  or  to give desired time. Touch the  to start. The maximum time is 90 mins.





If at any time an error has been made, simply touch the  (stop) and start again.

11. Steam + Microwave

Touch the  twice to get into the steam + microwave function, the screen will show the default power of 300W, default steam level of 30° and default time of 10:00 minutes.

To change the wattage, touch the  and when the 300W is flashing touch the  or  to increase or decrease the power to 100W - 900W.

To change the steam level, touch the  again and when the 30° is flashing touch the  or  to increase or decrease the steam level. The steam level that can be chosen depends on the microwave power (see table below).

To change the time, touch the  and when the 10:00 minutes is flashing, touch  or  to give desired time. Touch the  to start. The maximum time depends on the power of the microwave chosen, up to 30 minutes for 900W and up to 90 minutes for lower wattage powers.





Power Level	100W	300W	450W	700W	900W
Steam Ratio	Up to 30	Up to 60	Up to 70	Up to 70	Up to 100

12. Steam + Convection/Fanned oven



Touch the  three times to get into the steam + convection/fanned oven function, the screen will show the default steam level of 30°, default temperature of 180°C and default time of 10:00 minutes.

To change the temperature, touch the  and when the 180°C is flashing touch the  to increase the temperature to 180 - 220°C.

To change the steam level, touch the  again and when the 30° is flashing touch the  to decrease the steam level to either 10 or 20.

To change the time, touch the  and when the 10:00 minutes is flashing, touch  or  to give desired time. Touch the  to start. The maximum time is 90 mins.

13. Defrost



Touch the /A once, the appliance will enter the defrost mode. You will notice the screen showing the defrost icon , the default defrost mode (D01), weight and time.

To confirm the defrost mode, touch the 





Touch the  or  to select the weight. Touch  to start defrosting.

14. Automatic Program Mode

There are auto cooking programs for both steam and non-steam cooking. Steam is S01-S40, and non-steam is P01-P40. There are 40 pre-programmed functions for each.

Touch the /A twice, the appliance will enter the non-steam automatic program mode. You will notice the screen showing the first automatic program P01, weight and time. If you touch the /A once more you will enter the steam automatic program mode and the screen will display the first automatic program S01.

To change the program, touch the  and use the  or  to select.



In this function the time to cook is determined by the weight. To change the weight, touch the  again and use the  or  to select the weight. Touch the  to start the program.

For all preprogrammed functions, please refer to the Automatic Program Index on page 17.

15. Cleaning

For best cleaning results, we recommend that you use detergent sodium citrate to descale. Follow the manufacturer's instructions on the packaging. It is suggested that the descaling function should be used after the steam function has been run for 20 hours.

15. Cleaning (cont'd)

Power up the system, touch the  to release and remove the water tank, fill 1000ml of fresh water into the water tank, adding a pack of descaling agent. Touch the /A four times to enter the cleaning function. You will notice the screen displays CLE, the time of 20:00 and current water level.

Touch  to start the program.



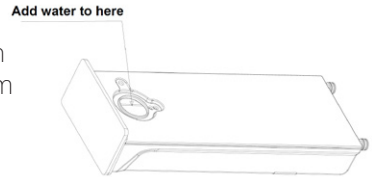

Once to cleaning program is finished wait 1 minute, take out the water tank and clean. Fill the water tank with fresh water and repeat the cleaning program.

Note: This appliance should not be shut down during the program. If it does shut down before the end of the program the cleaning program must be selected and started again.



16. Reset / Child safety lock

To **reset**, while inputting functions, programs, times, temperatures etc. touch the .

To **lock**, press and hold  for 3 seconds, there will be a long beep to inform you that you have entered the child safety lock state and you will notice a  on the screen. To unlock, press and hold  for 3 seconds again and there will be another beep to indicate the child safety lock has been released and the  will disappear.

17. Display Functionality

Whilst choosing settings, the oven will confirm an option automatically if you do not touch a button for 10 seconds. (Excluding when you initially set the clock on first use.)

When the appliance is in the setting or paused state, including the auto menu and defrost program, if there is no operation in 5 minutes it will turn itself off.

The oven light will be on at all times that the door is open or the oven is paused.

If the oven door is opened during the cooking process you must touch the  to continue cooking.

The  can be touched in any state to release the water tank.

UTENSILS AND MATERIALS

Materials you CAN use in the oven when using the microwave function

Utensils	Remarks
Dinnerware	Microwave-safe only. Do not use cracked or chipped dishes.
Glass jars	Always remove lid. Use only to heat food until just warm. Most glass jars are not heat resistant and may break.
Glassware	Heat-resistant oven glassware only. Make sure there is no metallic trim. Do not use cracked or chipped dishes.
Oven cooking bags	Do not close with metal tie. Make slits to allow steam to escape.
Paper plates/cups	Use for short-term cooking/warming only. Do not leave oven unattended while cooking.
Paper towels	Use to cover food for reheating and absorbing fat. Use with supervision for short-term cooking only.
Parchment paper	Use as a cover to prevent splattering or a wrap for steaming.
Plastic	Microwave-safe only. Some plastic containers soften, as the food inside gets hot. "Boiling bags" and tightly closed plastic bags should be slit, pierced or vented as directed by manufacturer.
Plastic wrap	Microwave-safe only. Use to cover food during cooking to retain moisture. Do not allow plastic wrap to touch food.
Thermometers	Microwave-safe only (meat and candy thermometers).
Wax paper	Use as a cover to prevent splattering and retain moisture.

Materials to be AVOIDED in the oven when using the microwave function

Utensils	Remarks
Aluminium foil	May cause arcing and could cause a fire in the oven.
Aluminium tray	May cause arcing. Transfer food into microwave-safe dish.
Food carton with metal handle	May cause arcing. Transfer food into microwave-safe dish.
Metal/metal trimmed utensils	Metal shields food from microwave energy. Trims may cause arcing.
Metal twist ties	May cause arcing and could cause a fire in the oven.
Paper bags	May cause a fire in the oven.
Plastic foam	May melt or contaminate the liquid inside when exposed to high temp.
Wood	Will dry out and may split or crack.

Please follow manufacturer's instructions for all materials and utensils.

AUTOMATIC PROGRAM INDEX

Steam Programs

Display	Food Item	Weight Options	Function Powers
S01	Trout	200 / 300 / 400 / 500 / 600	Steam 100% + 300W
S02	Salmon Fillet	200 / 300 / 400 / 500 / 600	Steam 100% + 100W
S03	Pike perch	200 / 300 / 400 / 500 / 600	Steam 100% + 300W
S04	Prawns	200 / 300 / 400 / 500 / 600	Steam 100%
S05	Halibut Fillet	200 / 300 / 400 / 500 / 600	Steam 100% + 300W
S06	Cockles	200 / 300 / 400 / 500 / 600	Steam 100% + 100W
S07	Cod Fillet	200 / 300 / 400 / 500 / 600	Steam 100% + 300W
S08	Herring	200 / 300 / 400 / 500 / 600	Steam 100% + 300W
S09	Tuna Fillet	200 / 300 / 400 / 500 / 600	Steam 100% + 100W
S10	Crab	2 / 3 / 4 / 5 / 6	Steam 100% + 300W
S11	Chicken leg	200 / 300 / 400 / 500 / 600	Steam 100% + 300W
S12	Chicken breast	200 / 300 / 400 / 500 / 600 / 700 / 800	Steam 100% + 300W
S13	Meatball	200 / 300 / 400 / 500 / 600	Steam 100% + 300W
S14	Turkey escalope	400 / 500 / 600 / 700 / 800	Steam 100% + 300W
S15	Pork Filet, whole	200 / 300 / 400 / 500 / 600	Steam 100% + 300W
S16	Sausages	200 / 300 / 400 / 500 / 600	Steam 100% + 100W
S17	Poached Eggs	1 / 3	Steam 100%
S18	Eggs, hard	1 / 3	Steam 100%
S19	Eggs, soft	1 / 3	Steam 100%
S20	Brown rice + water	200g + 400ml / 400g + 800ml	Steam 100% + 450W / Steam 100% + 300W
S21	Rice + water	200g + 300ml / 400g + 600ml	Steam 100% + 450W / Steam 100% + 300W
S22	Eggplant / Aubergine	200 / 300 / 400 / 500 / 600	Steam 100% + 300W
S23	Beans	200 / 300 / 400 / 500 / 600	Steam 100% + 300W
S24	Broccoli	200 / 300 / 400 / 500 / 600	Steam 100%
S25	Cauliflower	200 / 300 / 400 / 500 / 600	Steam 100% + 300W
S26	Peas	200 / 300 / 400 / 500 / 600	Steam 100% + 300W

Display	Food Item	Weight Options	Function Powers
S27	Potatoes with skin (whole, small)	1 / 2 / 3 / 4	Steam 100% + 300W
S28	Potatoes with skin (whole, big)	1 / 2 / 3 / 4	Steam 100%
S29	Potatoes without skin (pieces)	200 / 300 / 400 / 500 / 600	Steam 100% + 300W
S30	Carrots	200 / 300 / 400 / 500 / 600	Steam 100% + 300W
S31	Corn cobs	2 / 3 / 4 / 5 / 6	Steam 100% + 300W
S32	Capsicum / Bell Peppers	200 / 300 / 400 / 500 / 600	Steam 100%
S33	Hot Peppers	200 / 300 / 400 / 500 / 600	Steam 100%
S34	Mushrooms	200 / 300 / 400 / 500 / 600	Steam 100% + 300W
S35	Leeks	200 / 300 / 400 / 500 / 600	Steam 100% + 300W
S36	Brussels Sprouts	200 / 300 / 400 / 500 / 600	Steam 100%
S37	Celery	200 / 300 / 400 / 500 / 600 / 700 / 800	Steam 100% + 300W
S38	Asparagus	200 / 300 / 400 / 500 / 600	Steam 100% + 100W
S39	Spinach	200 / 300 / 400 / 500 / 600	Steam 100% + 300W
S40	Zucchini / Courgette	200 / 300 / 400 / 500 / 600	Steam 100% + 300W

Non-steam Programs

Display	Food Item	Weight Options	Function Powers
P01	Melted Chocolate	100 / 150 / 200	450W
P02	Melted Butter	100 / 150 / 200	450W
P03	Sweet Potato	200 / 400 / 600	100W + 220°C
P04	Chicken Whole	800 / 1000 / 1200	100W + 220°C
P05	Chicken Leg	200 / 300 / 400 / 500 / 600 / 700 / 800	450W + 220°C
P06	Chicken Wings	200 / 300 / 400 / 500 / 600 / 700 / 800	300W + 220°C
P07	Fish Whole	1 / 2 / 3	100W + 220°C
P08	Fish Steak	200 / 300 / 400 / 500 / 600	100W + 220°C
P09	Fresh Pizza	200 / 300 / 400 / 500 / 600	Preheat / 200°C
P10	Frozen Pizza	200 / 300 / 400	100W + 220°C
P11	Cake	400 / 500 / 600	Preheat / 150°C
P12	Roast Pork	400 / 500 / 600 / 700 / 800 / 900 / 1000	450W + 220°C

Display	Food Item	Weight Options	Function Powers
P13	Chicken kebabs	200 / 300 / 400 / 500 / 600	100W + 220°C
P14	Shrimp	200 / 400 / 600	Preheat / 220°C
P15	Beef Steak	400 / 500 / 600 / 700 / 800 / 900 / 1000	100W + 220°C
P16	Barbecued Spare Ribs	200 / 400 / 600	100W + 220°C
P17	Chocolate Cookies	500	Preheat / 180°C
P18	Lemon Cookies	400	Preheat / 200°C
P19	Sausage	200 / 400 / 600	Preheat / 220°C
P20	Finger Food	200 / 300 / 400	Preheat / 220°C
P21	Reheat	200 / 300 / 400 / 500 / 600	900W
P22	Potato	1 / 2 / 3	900W
P23	Beverage	1 / 2 / 3	900W
P24	Pasta	100 (+800ml cold water) / 150 (+1000ml cold water) / 200 (+1200ml cold water)	700W
P25	Soup	1 / 2 / 3	900W
P26	Pizza	1 / 2 / 3	900W
P27	Muffin	1 / 2 / 3 / 4	900W
P28	Oatmeal	50 (+500ml water) / 100 (+1000ml water) / 150 (+1500ml water)	900W / 450W
P29	Baked Apple	2 / 3 / 4	700W
P30	Sandwich	1 / 2 / 3	900W
P31	Popcorn	50 / 100	900W
P32	Fudge Brownies	800	100W + 180°C
P33	Bread	100 / 150 / 200	Grill Level 3
P34	Chicken Nuggets	200 / 300 / 400 / 500 / 600	100W + 220°C
P35	French Fries	200 / 300 / 400 / 500	100W + 220°C
P36	Oatmeal Raisin Cookies	600	Preheat / 180°C
P37	Pecan Crisps	500	Preheat / 180°C
P38	Peanut Chocolate Cookies	500	Preheat / 180°C
P39	Hamburger	2 / 4 / 6	100W + 220°C
P40	Muffin	840 (70g x 12)	Preheat / 180°C

CLEANING

The water inside the oven and in the water tank should be cleaned up after each use.

WARNING: Unplug the appliance from the power supply before cleaning

1. Clean the cavity of the oven after using with a slightly damp cloth.
2. When the door frame, seal and neighbouring parts are dirty they must be cleaned carefully with a damp cloth.
3. When cleaning the oven door glass do NOT use harsh abrasive cleaners or sharp metal scrapers to clean as this may result in scratching and damaging the surface or even shattering the glass.

Tip - For easier cleaning of the cavity walls place half a lemon in a bowl with 300ml of water and start up the microwave on full power for 10 minutes. Wipe the oven clean using a soft, dry cloth.

MAINTENANCE

Defect codes that may occur during steam functions:

E-06 Water tank is not closed properly.

E-05 Water system is abnormal due to the water sensor, water pipe, water pump or water tank - please contact a service agent.

Troubleshooting

Scenario	Possible Cause	Response / Remedy
Dim oven light.	In low power microwave cooking the oven light may become dim.	This is normal, no response is needed.
Steam accumulating on door.	When cooking, steam may come out of food. Most will come from the vents but some may accumulate on cool places like the oven door.	This is normal, wipe away after use.

Scenario	Possible Cause	Response / Remedy
Oven cannot be started.	Power cord not plugged in tightly.	Unplug then plug in again after 10 seconds.
	Fuse blowing.	Replace fuse or reset circuit breaker.
	Trouble with outlet.	Test outlet with other electrical appliances.
Oven does not heat.	Door not closed properly.	Ensure door is closed properly.

If the unit fails to operate efficiently, is broken or other problems arise, unplug and do not operate.

Ask for advice by calling the Customer Care Centre on 1300 556 816 (AU) or 0800 666 2824 (NZ).

DISPOSAL



If in future you need to dispose of this product please contact your local government for information regarding the collection systems available. If electrical appliances are disposed of in landfills or dumps, hazardous substances can leak into the ground water, polluting the food chain and damaging your health and well-being.



MODEL NO.	IB45CS
Rated Voltage	230 - 240V ~50Hz
Rated Input Power (Microwave)	1550W
Rated Output Power (Microwave)	900W
Rated Output Power (Grill)	1200W
Rated Input Power (Convection)	1900W
Rated Input Power (Steam)	1500W
Rated Input Power (Maximum)	3000W
Oven Capacity	34L
External Dimensions (HxWxDmm)	454 x 595 x 525
Net Weight (kgs)	33

WARRANTY

The warranty period is 3 years from the date of purchase in Australia and 2 years from the date of purchase in New Zealand. For service advice, please contact the Customer Care Centre on 1300 556 816 (AU) / +64 9 274 8265 (NZ).

Glen Dimplex Australia Pty Ltd
1340 Ferntree Gully Road,
Scoresby 3179, Victoria
Australia
Ph: 1300 556 816
Fax: 1800 058 900
sales@glendimplex.com.au

Glen Dimplex Australasia Ltd
38 Harris Road, East Tamaki,
Auckland 2013
New Zealand
Ph: 09 274 8265
Fax: 09 274 8472
sales@glendimplex.co.nz